



**KLAUS
HUFNAGL**
BETONWAREN

PLANST DU NOCH ... ODER BAUST DU SCHON?

WIR HABEN DIE STEINE!

MULTI-STONE

VON K. H.

In Standardmaß oder individuell:
Wir fertigen Ihren MULTI-STONE von K.H.
Schnell & präzise.



*Jetzt scannen &
Kontakt Daten
direkt aufs Handy
bekommen!*



POSITIVE ASPEKTE

MULTI-STONE VON K.H.



- ✓ MULTI-STONE VON K.H.
vielseitig einsetzbar
- ✓ Individuelle Größen oder
Sonderanfertigungen
- ✓ Betonqualität min. C 25/30
- ✓ mobiles Bauwerk mit
eingearbeiteten
Gewindeankern & Seilschlaufen
- ✓ Regelmäßige Beton- und
Produktprüfung durch PÜZ Bau

Sie haben **keinerlei Platzeinbußen**, da der **MULTI-STONE von K.H.** aufgrund seines Eigengewichtes und den nach oben hervorstehenden Noppen standfest ist.

*Gefertigt nach
höchsten Maßstäben
und Richtlinien*

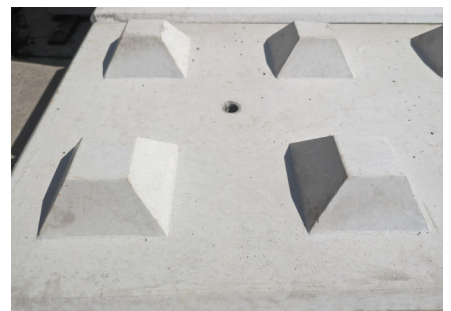

STANDARDGRÖSSEN & MASSANFERTIGUNGEN

Sie sind auf der Suche nach einer **flexibel gestaltbaren Systembauweise**, welche sich problemlos und in kurzer Zeit veränderten Situationen anpassen kann?

WIR HABEN DIE LÖSUNG: MULTI-STONE VON K.H.

Standardgrößen	Größe L / B / H - cm	ca. Gewicht to.	Deckfläche m ²
Typ 30	150 / 30 / 30	0,33	0,45
Typ 36	150 / 30 / 60	0,65	0,90
Typ 60	150 / 60 / 60	1,30	0,90
Typ 40	160 / 40 / 40	0,62	0,64
Typ 48	160 / 40 / 80	1,23	1,28
Typ 80	160 / 80 / 80	2,46	1,28
Typ Stellwand	200 / 54 / 90	1,59	1,80
Typ Multibank	160 / 80 / 80	1,68	1,28

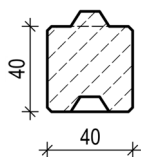

Typ 40

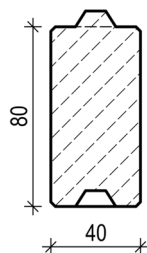

Typ 48

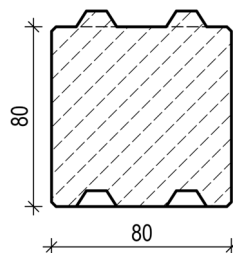

Typ 80

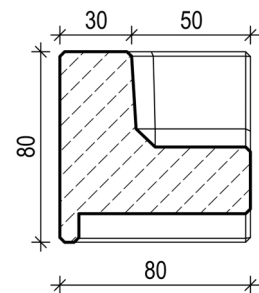

Typ Multibank

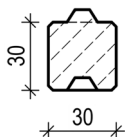

Typ 30

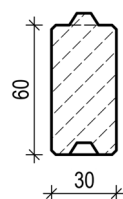

Typ 36

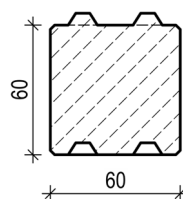

Typ 60

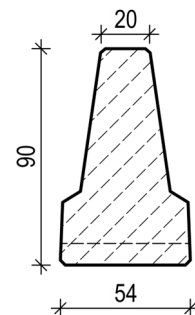

Typ Stellwand

OPTIMALE LÖSUNG

Der **MULTI-STONE von K.H.** ist in jeder Hinsicht **die Lösung für ALLE**, die eine getrennte bzw. individuelle Lagerhaltung benötigen oder als flexible Trennwand nutzen möchten:

- ✓ Privat & Gewerblich
- ✓ Deponien
- ✓ Garten- & Landschaftsbau
- ✓ Zerlegebetriebe
- ✓ Recyclingunternehmen
- ✓ Industrie
- ✓ Kommunen
- ✓ Landwirtschaft
- ✓ Bauhöfe



?

Sie benötigen spezielle Maße oder Formen?

Wir beraten Sie gerne!

Tel. 08166 / 1318

info@hufnagl-betonwaren.de

www.hufnagl-betonwaren.de

*Jetzt Angebot
anfordern!*



Beispiele & Anwendungen: Industrie & Landwirtschaft



Abb.: Trennwände



Abb.: Hangabsicherung



Abb.: Außenwand



Abb.: Begrenzungswand

Jetzt Angebot
anfordern!



Beispiele & Anwendungen: Privater Bereich



Abb.: Multi-Bank



Abb.: Schüttboxen



Abb.: Stellwand / Begrenzungssteine / Hochwasserschutz



Abb.: Vorgarten / Terrasse / Zaun

Jetzt Angebot
anfordern!



Sonderanfertigungen:

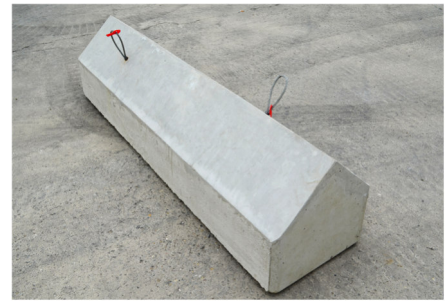

Auf Wunsch:

Versetzen der Steine mit LKW-Kran



Sie benötigen spezielle Maße oder Formen?

Wir beraten Sie gerne!

Tel. 08166 / 1318

info@hufnagl-betonwaren.de

www.hufnagl-betonwaren.de

*Jetzt Angebot
anfordern!*



MULTI-STONE Typ 30

Typ 30

ca.0,33 to.

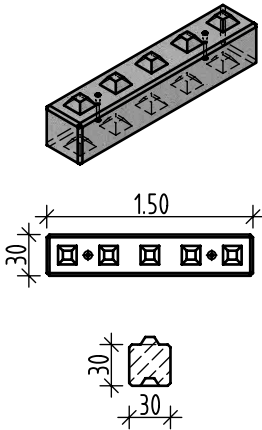

Typ 30-1

ca.0,26 to.

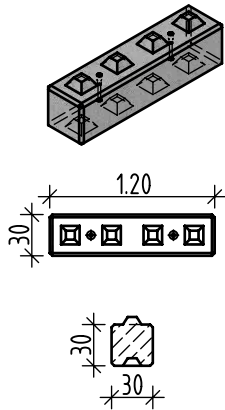

Typ 30-2

ca.0,20 to.

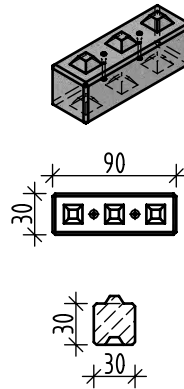

Typ 30-3

ca.0,13 to.

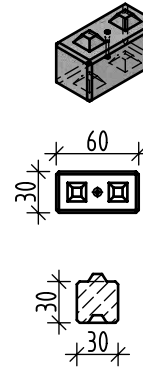

Typ 30-4

ca.0,06 to.

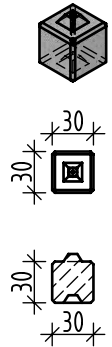

Typ 30-5

ca.0,33 to.

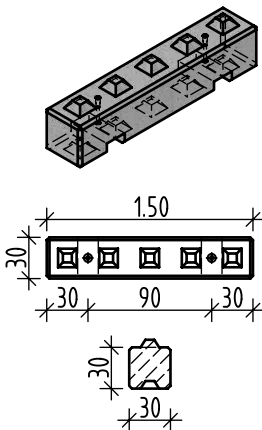

Typ 30-6

ca.0,32 to.

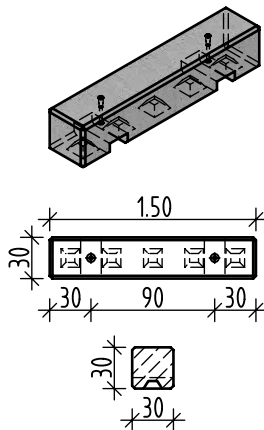

Typ 30-7

ca.0,32 to.

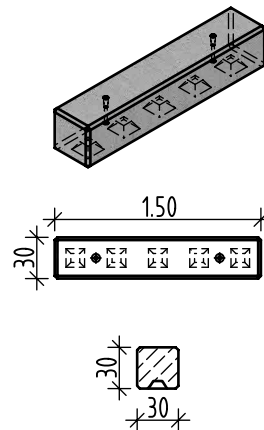

Typ 30-8

ca.0,24 to.

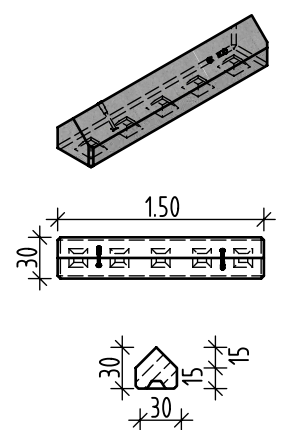

Typ 30-9

ca.0,26 to.

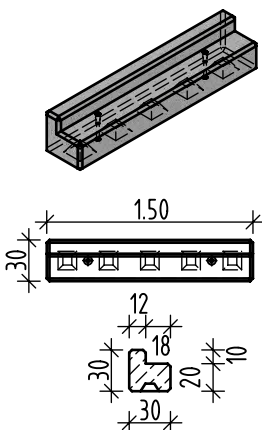

Typ 30-10

ca.0,31 to.

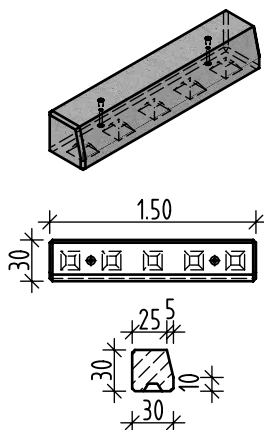

- ▶ Stapler-Aussparungsprofil Größe (Gabelstapler-Transportschuhe) ca. 15 x 8 cm
- ▶ Typ 30-7, 30-8, 30-9, 30-10 gibt es auch in den Längen: 120 cm, 90 cm, 60 cm, 30 cm
- ▶ alle Maße sind ca. Maße, mit Gewindeanker M16



KLAUS HUFNAGL
BETONWAREN

Dorfstraße 17 08166 - 1318
85391 Leonhardsbuch 08166 - 3618
info@hufnagl-betonwaren.de www.hufnagl-betonwaren.de

Multi-Stone Varianten 30/30

Unterschrift / Freigabe erteilt:

Datum: 15.08.2023

Maßstab: ---

Ersteller: RING

Index:

MULTI-STONE Typ 36

Typ 36

ca.0,65 to.

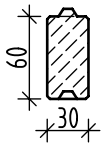
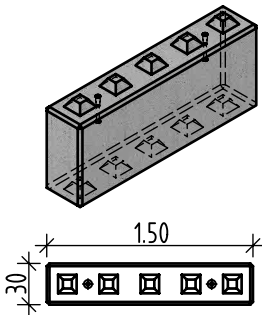

Typ 36-1

ca.0,52 to.

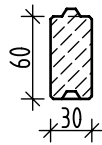
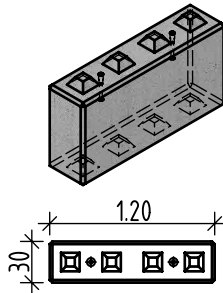

Typ 36-2

ca.0,39 to.

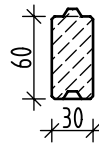
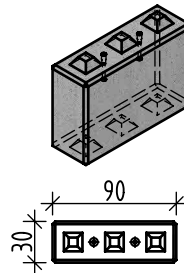

Typ 36-3

ca.0,26 to.

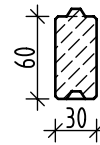
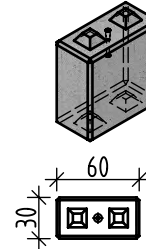

Typ 36-4

ca.0,13 to.

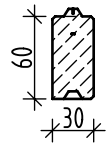
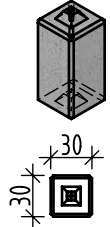

Typ 36-5

ca.0,65 to.

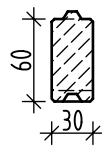
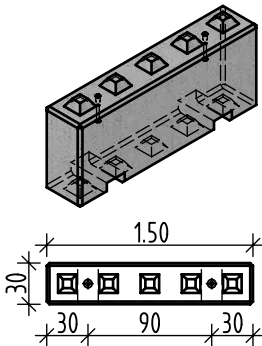

Typ 36-6

ca.0,64 to.

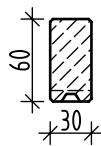
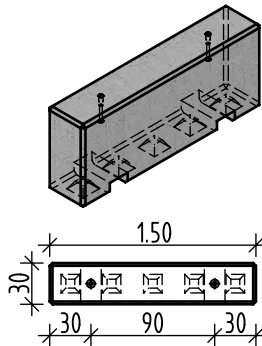

Typ 36-7

ca.0,64 to.

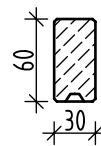
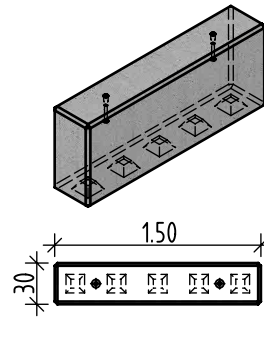

Typ 36-8

ca.0,58 to.

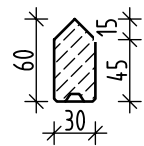
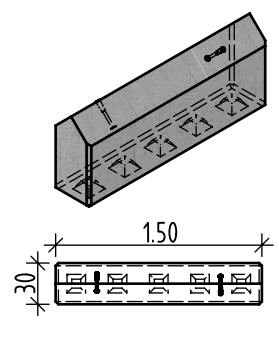

Typ 36-9

ca.0,50 to.

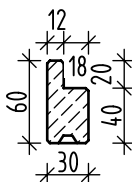
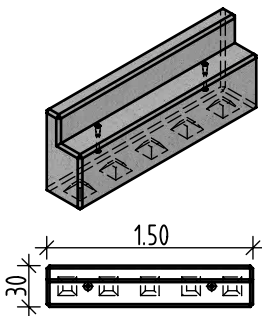

Typ 36-10

ca.0,54 to.

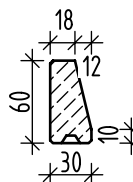
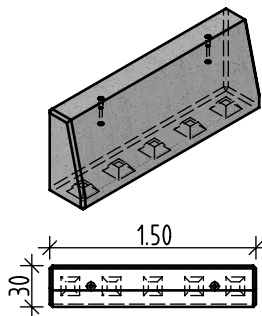

- ▶ Stapler-Aussparungsprofil Größe (Gabelstapler-Transportschuhe) ca. 15 x 8 cm
- ▶ Typ 36-7, 36-8, 36-9, 36-10 gibt es auch in den Längen: 120 cm, 90 cm, 60 cm, 30 cm
- ▶ alle Maße sind ca. Maße, mit Gewindeanker M16



KLAUS HUFNAGL
BETONWAREN

Dorfstraße 17 08166 - 1318
85391 Leonhardsbuch 08166 - 3618
info@hufnagl-betonwaren.de www.hufnagl-betonwaren.de

Multi-Stone Varianten 30/60

Unterschrift / Freigabe erteilt:

Datum: 15.08.2023

Maßstab: ---

Ersteller: RING

Index:

MULTI-STONE Typ 60

Typ 60

ca.1,30 to.

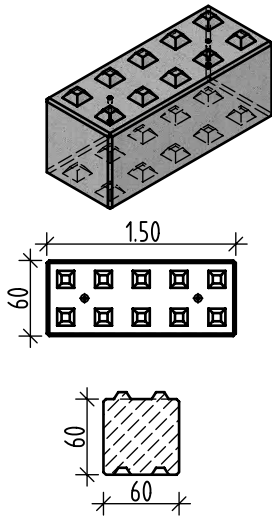

Typ 60-1

ca.1,04 to.

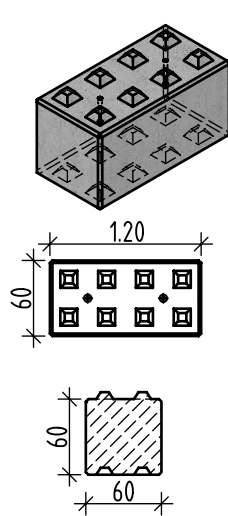

Typ 60-2

ca.0,78 to.

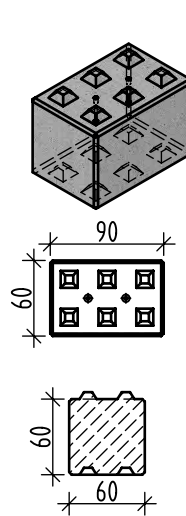

Typ 60-3

ca.0,52 to.

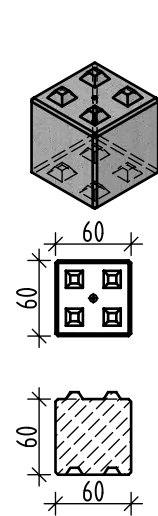

Typ 60-4

ca.0,26 to.

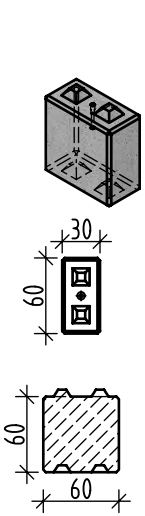

Typ 60-5

ca.1,30 to.

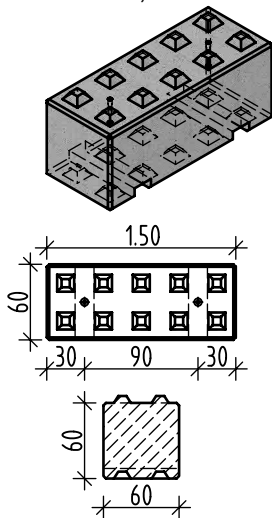

Typ 60-6

ca.1,29 to.

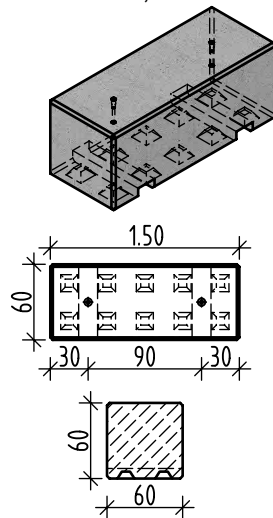

Typ 60-7

ca.1,29 to.

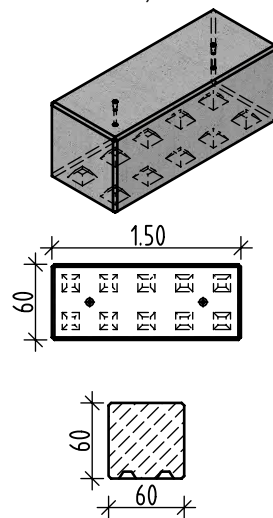

Typ 60-8

ca.0,97 to.

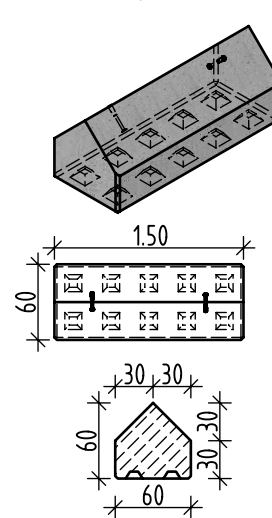

Typ 60-9

ca.0,94 to.

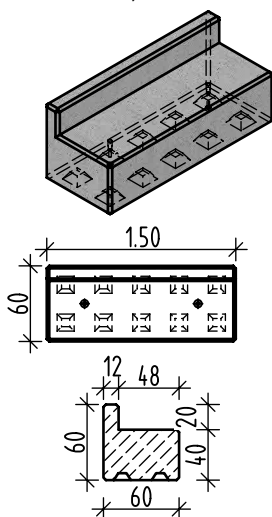

Typ 60-10

ca.1,19 to.

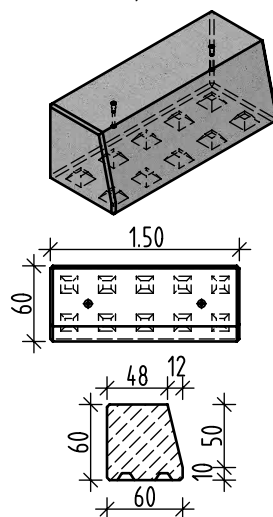

- ▶ Stapler-Aussparungsprofil Größe (Gabelstapler-Transportschuhe) ca. 15 x 8 cm
- ▶ Typ 60-7, 60-8, 60-9, 60-10 gibt es auch in den Längen: 120 cm, 90 cm, 60 cm, 30 cm
- ▶ alle Maße sind ca. Maße, mit Gewindeanker M20



KLAUS HUFNAGL
BETONWAREN

Dorfstraße 17 08166 - 1318
85391 Leonhardsbuch 08166 - 3618
info@hufnagl-betonwaren.de www.hufnagl-betonwaren.de

Multi-Stone Varianten 60/60

Unterschrift / Freigabe erteilt:

Datum: 15.08.2023

Maßstab: ---

Ersteller: RING

Index:

MULTI-STONE Typ 40

Typ 40

ca.0,62 to.

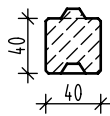
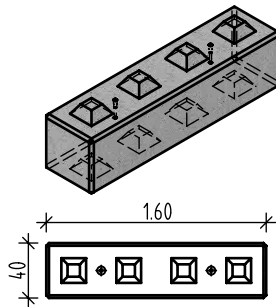

Typ 40-1

ca.0,46 to.

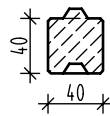
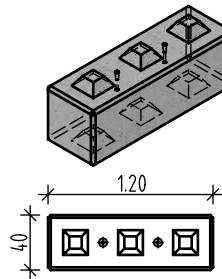

Typ 40-2

ca.0,31 to.

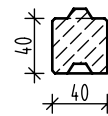
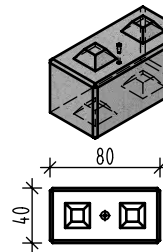

Typ 40-3

ca.0,16 to.

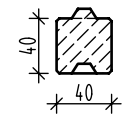
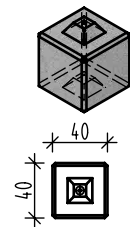

Typ 40-4

ca.0,62 to.

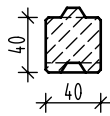
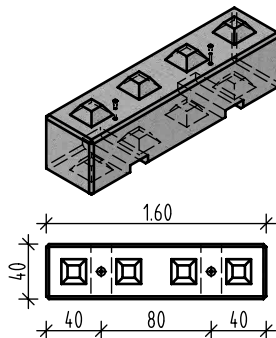

Typ 40-5

ca.0,61 to.

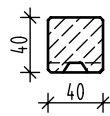
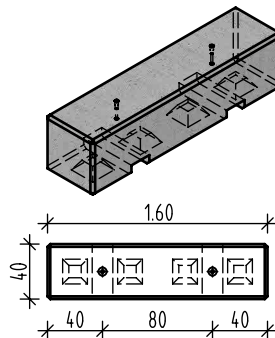

Typ 40-6

ca.0,61 to.

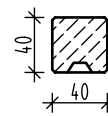
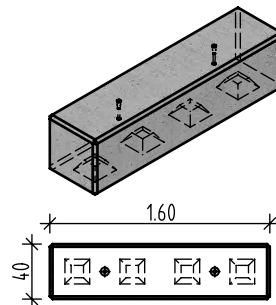

Typ 40-7

ca.0,47 to.

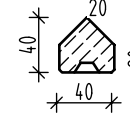
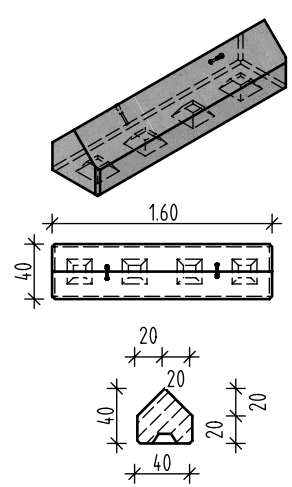

Typ 40-8

ca.0,39 to.

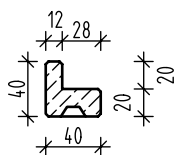
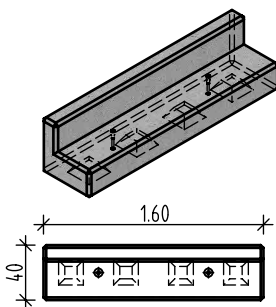

Typ 40-9

ca.0,58 to.

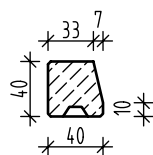
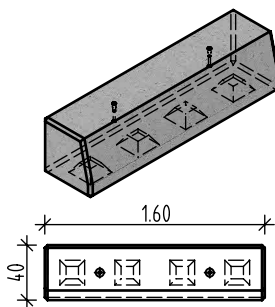

- ▶ Stapler-Aussparungsprofil Größe (Gabelstapler-Transportschuhe) ca. 15 x 8 cm
- ▶ Typ 40-6, 40-7, 40-8, 40-9 gibt es auch in den Längen: 120 cm, 80 cm, 40 cm
- ▶ alle Maße sind ca. Maße, mit Gewindeanker M16



**KLAUS
HUFNAGL**
BETONWAREN

Dorfstraße 17 08166 - 1318
85391 Leonhardsbuch 08166 - 3618
info@hufnagl-betonwaren.de www.hufnagl-betonwaren.de

Multi-Stone Varianten 40/40

Unterschrift /
Freigabe erteilt:

Datum: 15.08.2023

Maßstab: ---

Ersteller: RING

Index:

MULTI-STONE Typ 48

Typ 48

ca. 1,23 to.

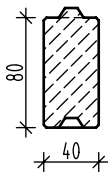
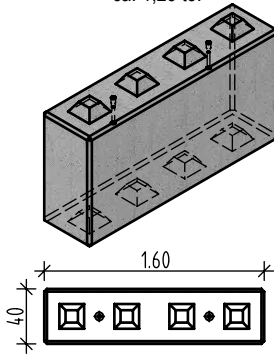

Typ 48-1

ca.0,93 to.

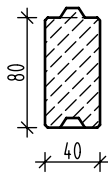
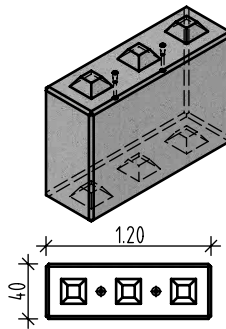

Typ 48-2

ca.0,62 to.

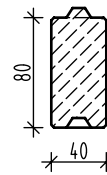
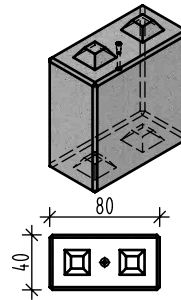

Typ 48-3

ca.0,31 to.

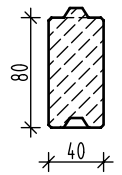
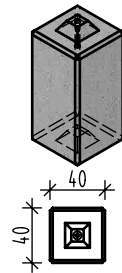

Typ 48-4

ca.1,23 to.

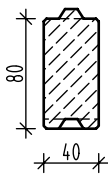
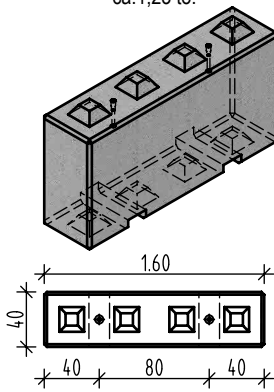

Typ 48-5

ca.1,22 to.

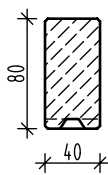
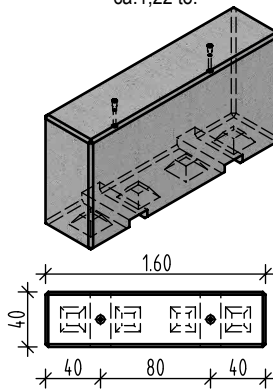

Typ 48-6

ca.1,22 to.

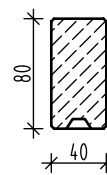
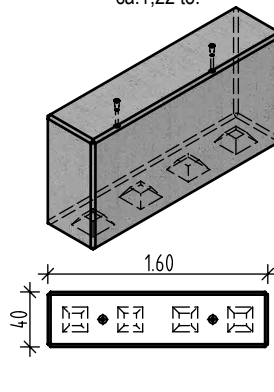

Typ 48-7

ca.1,08 to.

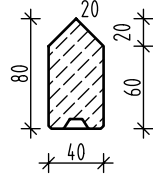
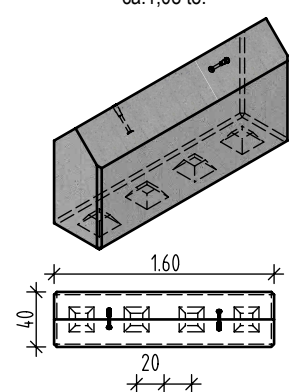

Typ 48-8

ca.1,22 to.

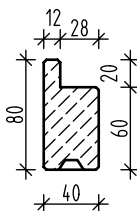
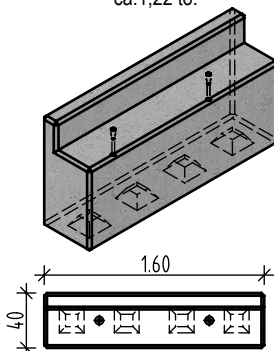

Typ 48-9

ca.1,00 to.

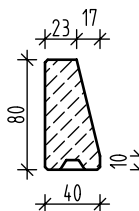
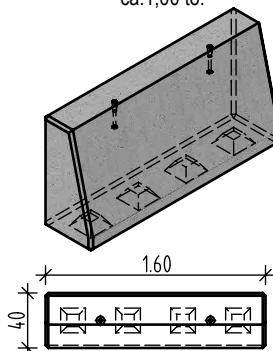

- ▶ Stapler-Aussparungsprofil Größe (Gabelstapler-Transportschuhe) ca. 15 x 8 cm
- ▶ Typ 48-6, 48-7, 48-8, 48-9 gibt es auch in den Längen: 120 cm, 80 cm, 40 cm
- ▶ alle Maße sind ca. Maße, mit Gewindeanker M20



KLAUS HUFNAGL
BETONWAREN

Dorfstraße 17
85391 Leonhardsbuch
info@hufnagl-betonwaren.de

08166 - 1318
08166 - 3618
www.hufnagl-betonwaren.de

Multi-Stone Varianten 40/80

Unterschrift /
Freigabe erteilt:

Datum: 15.08.2023

Maßstab: ---

Ersteller: RING

Index:

MULTI-STONE Typ 80

Typ 80

ca. 2,46 to.

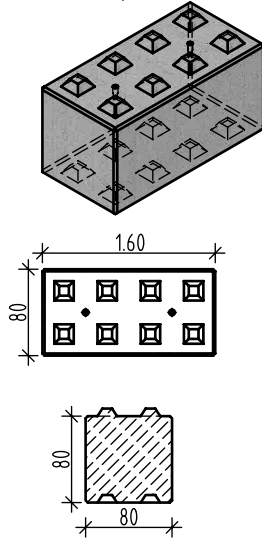

Typ 80-1

ca. 1,84 to.

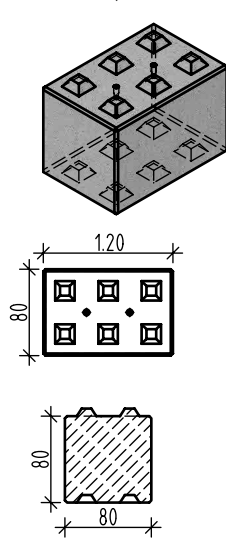

Typ 80-2

ca. 1,23 to.

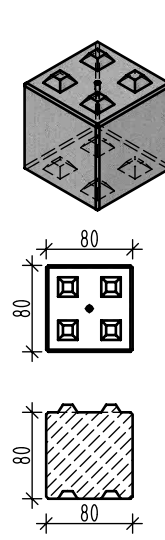

Typ 80-3

ca. 0,61 to.

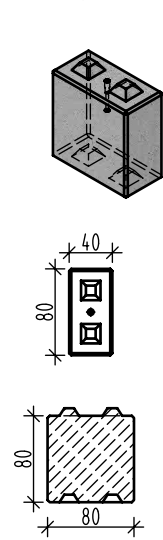

Typ 80-4

ca. 2,46 to.

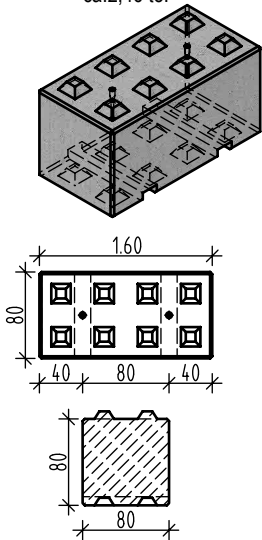

Typ 80-5

ca. 2,45 to.

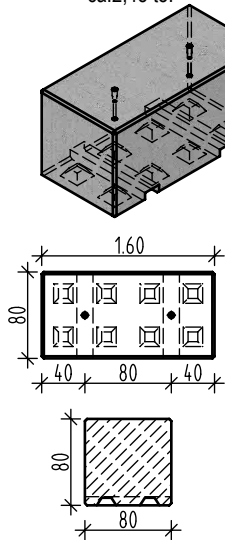

Typ 80-6

ca. 2,45 to.

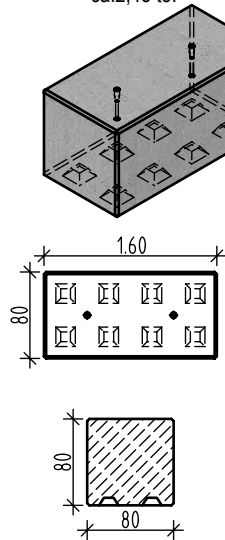

Typ 80-7

ca. 1,85 to.

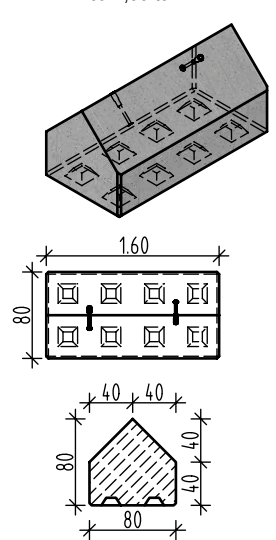

Typ 80-8

ca. 1,92 to.

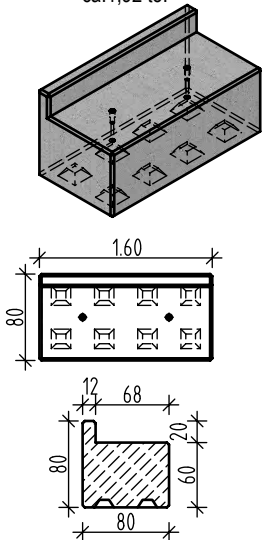

Typ 80-9

ca. 2,23 to.

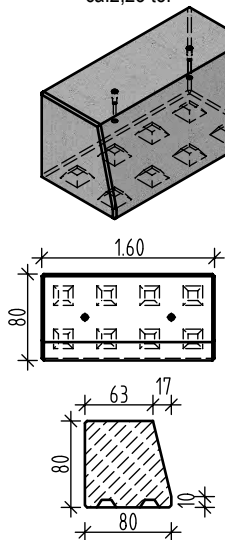

- ▶ Stapler-Aussparungsprofil Größe (Gabelstapler-Transportschuhe) ca. 15 x 8 cm
- ▶ Typ 80-6, 80-7, 80-8, 80-9 gibt es auch in den Längen: 120 cm, 80 cm, 40 cm
- ▶ alle Maße sind ca. Maße, mit Gewindeanker M30



KLAUS HUFNAGL
BETONWAREN

Dorfstraße 17 08166 - 1318
85391 Leonhardsbuch 08166 - 3618
info@hufnagl-betonwaren.de www.hufnagl-betonwaren.de

Multi-Stone Varianten 80/80

Unterschrift / Freigabe erteilt:

Datum: 15.08.2023

Maßstab: ---

Ersteller: RING

Index:

MULTI-STONE

Typ Stellwand

Typ 200

ca. 1,59 to.

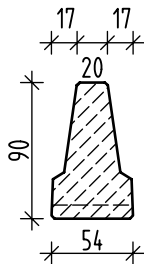
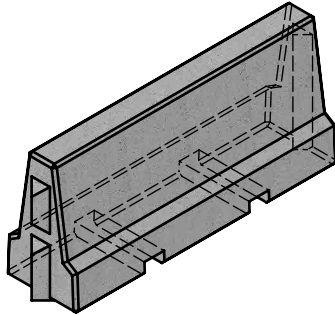

Typ 150

ca. 1,19 to.

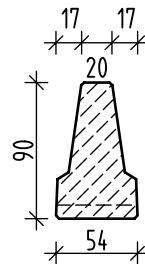
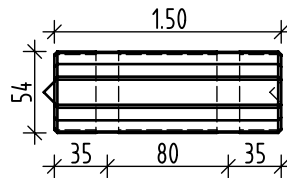
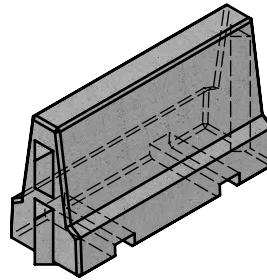

Typ 100

ca. 0,80 to.

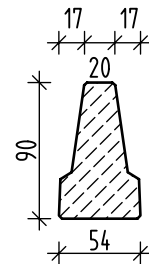
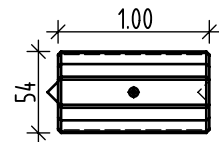
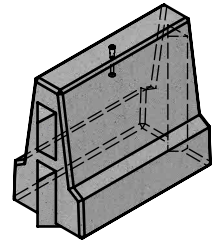

Typ 50

ca. 0,40 to.

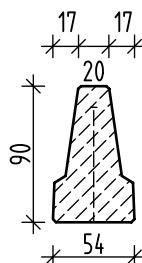
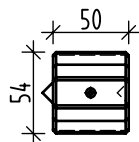
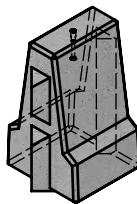

- ▶ Stapler-Aussparungsprofil Größe (Gabelstapler-Transportschuhe) ca. 15 x 8 cm
- ▶ Typ 100 und Typ 50 mit Gewindeanker M20
- ▶ alle Maße sind ca. Maße



**KLAUS
HUFNAGL**
BETONWAREN

Dorfstraße 17

85391 Leonhardsbuch

info@hufnagl-betonwaren.de

08166 - 1318

08166 - 3618

www.hufnagl-betonwaren.de

Multi-Stone Stellwand

Unterschrift /
Freigabe erteilt:

Datum: 15.08.2023

Maßstab: ---

Ersteller: RING

Index:

MULTI-STONE

Typ Multibank

Typ 1

ca. 1,68 to.

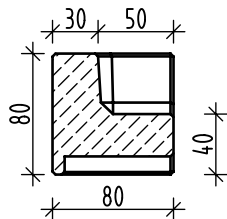
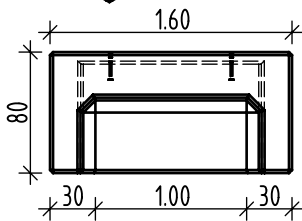
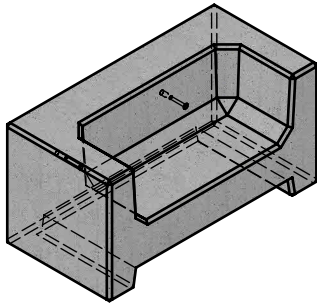

Typ 2

ca. 1,65 to.

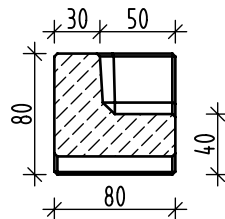
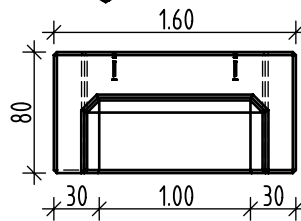
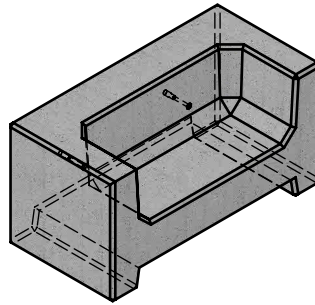

Typ 3

ca. 1,90 to.

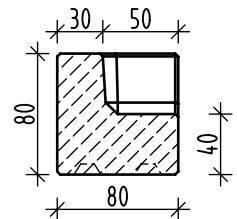
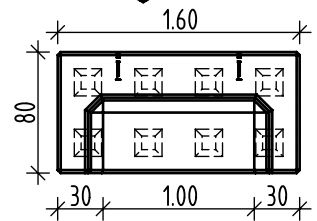
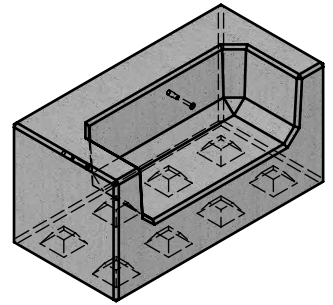

Typ 4

ca. 1,92 to.

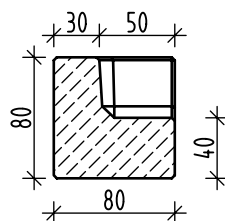
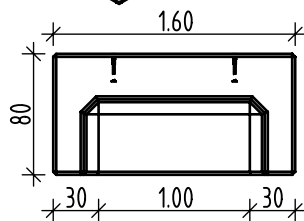
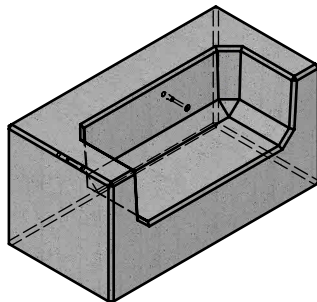

- ▶ untere Aussparung ca. 12 cm hoch
- ▶ mit eingebauten Gewindeanker M20
- ▶ alle Maße sind ca. Maße



**KLAUS
HUFNAGL**
BETONWAREN

Dorfstraße 17

85391 Leonhardsbuch

info@hufnagl-betonwaren.de

08166 - 1318

08166 - 3618

www.hufnagl-betonwaren.de

Multi-Stone Multibank

Unterschrift /
Freigabe erteilt:

Datum: 15.08.2023

Maßstab: ---

Ersteller: RING

Index:

INTERESSE? JETZT ANGEBOT ANFORDERN!

Ob Standardmaß oder individuell:
Wir fertigen Ihren **MULTI-STONE von K.H.**
Schnell & präzise.

*Fragen?
Rufen Sie uns an:
Tel. 08166 / 1318*



WICHTIG!

Sie wollen **schnellstmöglich** ein Angebot?
Dann notieren Sie hier Ihre **Wunsch-Abmessungen**
und / oder eine **kleine Skizze** – und danach einfach
einscannen oder per Handyfoto **als E-Mail senden!**

Ihre Kontaktdaten:
Firma
Ansprechpartner
Straße & Hausnr.
PLZ / Ort
Tel. / Mobilnummer
E-Mail

Hinweise: Abbildungen: Originale können in Farbe und Struktur abweichen *** Keine Sichtbetonqualität *** Auf frostfreiem & ausreichend tragfähigem Untergrund aufstellbar *** Versetzen der Steine gegen Aufpreis möglich *** Seilschlaufen gegen Aufpreis *** Abweichungen möglich.



**KLAUS
HUFNAGL**
BETONWAREN

Klaus Hufnagl Betonwaren GmbH
Dorfstraße 17
85391 Leonhardsbuch
Tel. 08166 / 1318
Fax 08166 / 3618

info@hufnagl-betonwaren.de
www.hufnagl-betonwaren.de

*Jetzt Angebot
anfordern!*

